



Wizard In-Stock

Temporary Revision 11/8/2021

Wizard In-Stock Program Temporary Revision 11/8/2021

Lead time 4 weeks

In-Stock Glazes

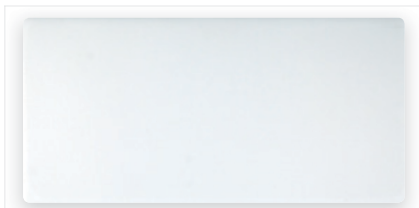

GlossWhite M-200,
(Solid), T1

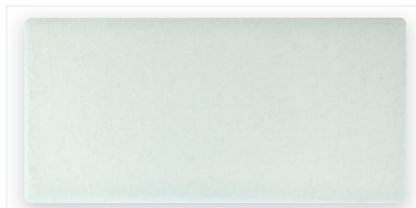

Crystal M-493
(Gloss Crackle, Clear), T2

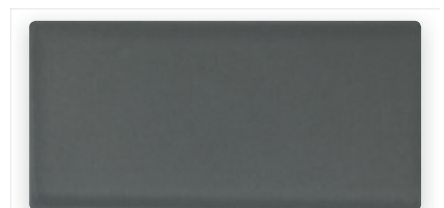

Iron City RC-3983 B
(Gloss Crackle, Clear), T2

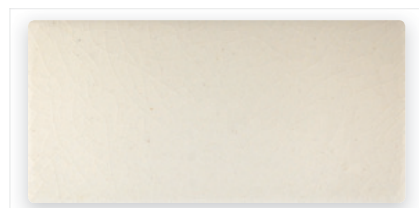

Polar A-867
(Gloss Crackle, Clear), T2

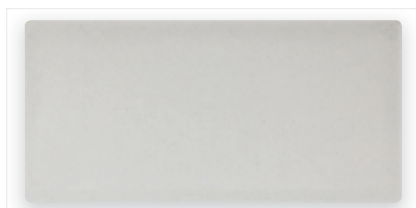

Fleece RC-269-A
(Gloss Crackle, Clear), T2



Variation is intrinsic to the beauty and warmth of handmade ceramic tile. Differences in size, shape, and glaze color from tile to tile and even within a single tile are intentional and should be expected. Due to limitations of the printing process, the glaze images are intended as a guide only. It is important to have a sample composed of several tile when making final glaze selections.

In-Stock Parts

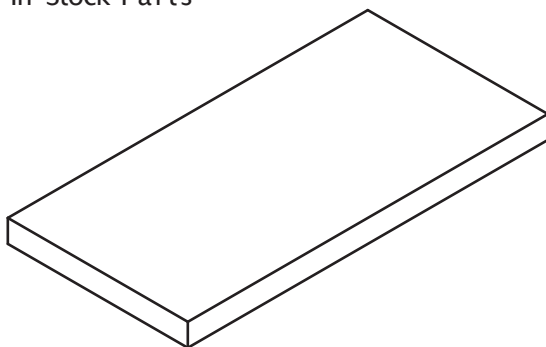

PL36
3x6 Field Tile

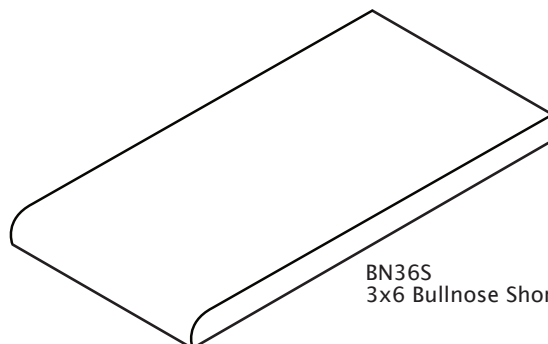

BN36S
3x6 Bullnose Short Side

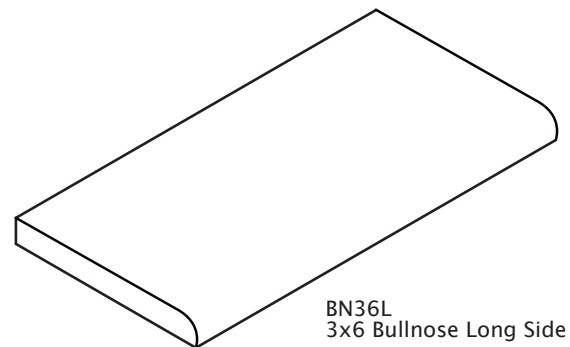

BN36L
3x6 Bullnose Long Side